

300 STILE
S/A D200 FOR OFFSET
PVD BUTT HINGE

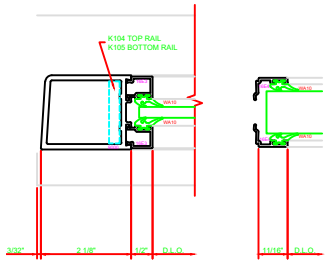

400 MEETING RAIL
D200

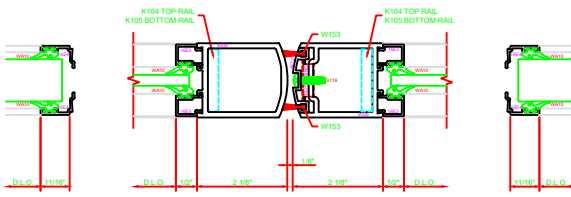

305 STILE
S/A D200 FOR OFFSET
PVD BUTT HINGE

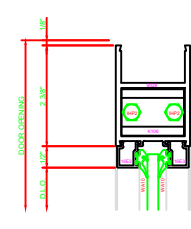
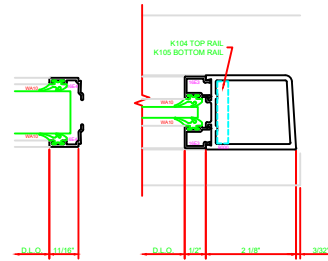

100 TOP RAIL
S/A D200

ERASE NOTE:
TOP RAIL FOR SURFACE CLOSERS OR
CORNER TYPE C.O.C. NOT FOR C.O.C.

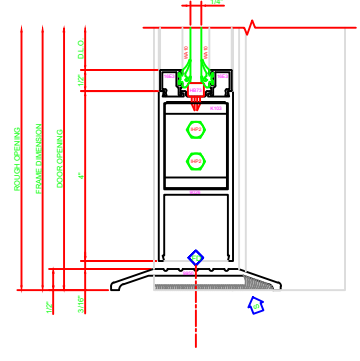
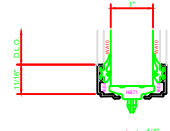
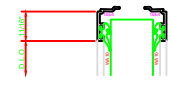

200 BOTTOM RAIL
S/A D200